



PIONEER INDUSTRIES, INC.
 3325 S. Garfield Ave
 Commerce, CA 90040
 (800) 338-9468
 www.pioneerind.com

INSTALLATION

Tools:



Adjustable Wrench



Teflon Tape



Rags



Model Number: 2MT700, 2AM700

Warnings and Notes:

Check with local plumbing code requirements before installation.
 This product should be installed by a local listed plumber.
Do not use plumbers putty on threads.

Installation Steps:

Deck Mount Pot-Filler

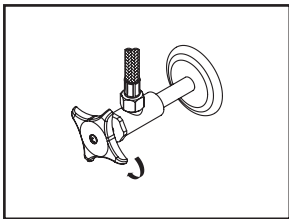

(1) Shut off water supply. Remove old faucet. Clean mounting surface in preparation for new faucet.

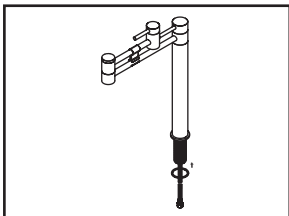

(2) Do not remove plastic arm bracket before finish installation to prevent damage on swivel arms. Be sure to place gasket underneath of faucet to form watertight seal.

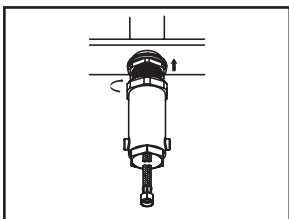

(3) Guide the faucet through mounting hole. Slide the washer from beneath the mounting surface. Install the locknut with the help of mounting tool

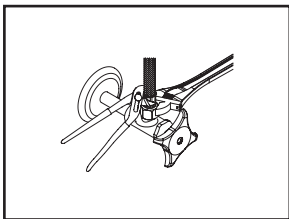

(4) Use faucet inlet supply hose to connect to supply stop. You may need adapter(not included) if supply stop outlet size is not 3/8" compression.

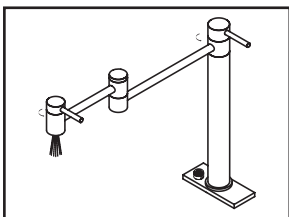

(6) Remove the aerator from the spout by turning counter-clockwise. Turn on supply stop. Check of any leaks. Make sure all the connection are secure. Open both handles. Flush and allow water to run at full flow for at least one minute. Turn off water. Replace the aerator.

Exploded Drawing (2MT700)

* Note: Please specify finish/color when ordering.

	ITEM #	DESCRIPTION
A	X-1200019*	Main Handle
B	X-3200004H	Ceramic Cartridge
C	X-1200018*	Secondary Handle
D	X-4200153	Gasket
E	X-4900041*	2.0 GPM Aerator
F	X-5200019	Mounting Kit
G	X-5200021	Mounting Tool
1	X-4400073*	Hole Cover
2	X-4900002	Allen Screw

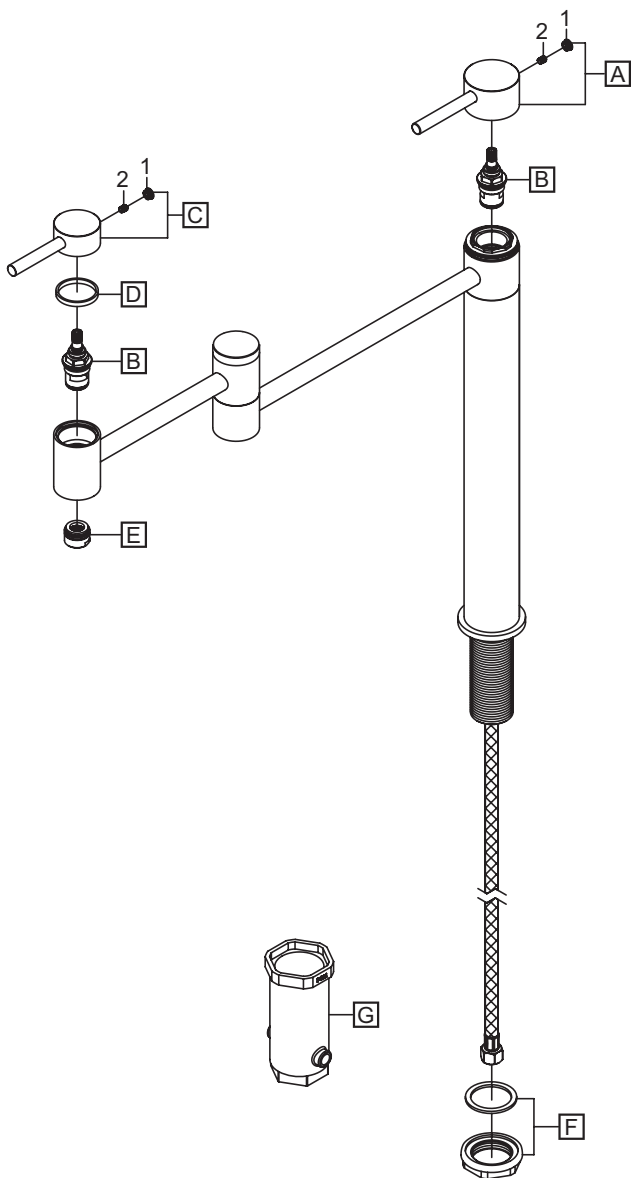

For more care information or trouble shooting inquiries
 about your Pioneer product, please call:
Pioneer Industries, Inc. (800) 338-9468
 Monday-Friday 8AM to 8PM EST (5AM to 5PM PST)
www.pioneerind.com

Exploded Drawing (2AM700)

* Note: Please specify finish/color when ordering.

	ITEM #	DESCRIPTION
A	X-1200010*	Americana Lever Handle
B	X-4200154*	Retainer Sleeve
C	X-3200004H	Ceramic Cartridge
D	X-4200093*	Handle Sleeve
E	X-4200067*	Handle Escutcheon
F	X-4900041*	2.0 GPM Aerator
G	X-5200019	Mounting Kit
H	X-5200021	Mounting Tool
1	X-4900042P*	Handle Button-Plain
2	X-4900043	Handle Screw

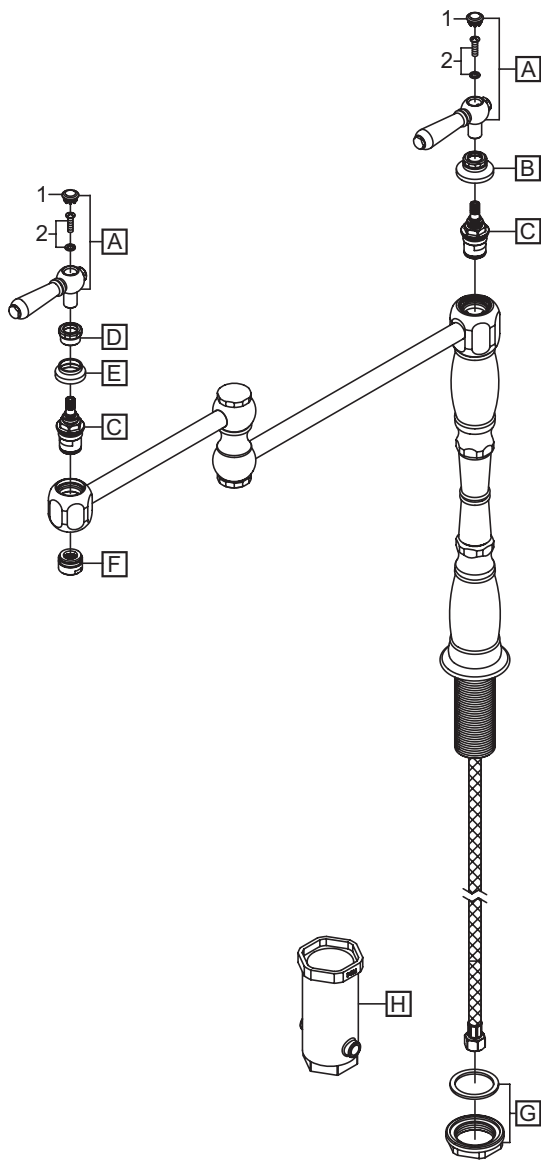

For more care information or trouble shooting inquiries
about your Pioneer product, please call:
Pioneer Industries, Inc. (800) 338-9468
Monday-Friday 8AM to 8PM EST (5AM to 5PM PST)
www.pioneerind.com